

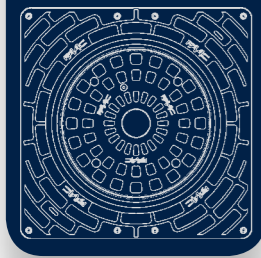

# J SERIES BOLLARDS

**FAAC**  
*Simply automatic.*



# Bollards Series

**FAAC bollards range.  
Endless solutions, performance beyond the standard**



**J Series**

**Innovative solutions to meet  
any application need**

**FAAC Hydraulic Technology,  
over 40 years of worldwide excellence**

**High quality components  
to ensure exceptional performance**

**«Design for Assembly» approach; products  
designed to simplify installation and  
maintenance**

**The strength of the FAAC Group;  
worldwide presence to support  
your project**

Solutions for vehicle traffic control in residential, commercial, industrial and urban areas with limited traffic and for perimeter protection security applications.



### **J200 Series** for residential areas

**(HA) Automatic**

To regulate vehicle access to residential areas

**(F) Fixed**

To complete installations with other retractable models for access control



### **J275 Series** for commercial, industrial and urban restricted access areas

**(HA) Automatic**

To regulate vehicular access to commercial, industrial and urban restricted access areas

**(SA) Semi-Automatic**

To regulate vehicle access to town centres, areas that are difficult to wire or occasionally open to traffic

**(F) Fixed**

To complete installations with other retractable models for access control



### **J355 M30-P1 Series** certified perimeter security

**(HA) Automatic**

To define, protect and regulate vehicle access to sensitive areas (embassies, military areas, etc.) and, in general, to sites with special security requirements





# Bollards for residential areas J200

## 1. J200HA AUTOMATIC

### RETRACTABLE TRAFFIC BOLLARD

The Automatic retractable traffic bollard FAAC J200HA is particularly suitable to regulate vehicle traffic in residential areas, ensuring an intelligent control, while maintaining the aesthetic appearance.

## 2. J200F FIXED TRAFFIC BOLLARD

The Fixed traffic bollard FAAC J200 does not require invasive installation work, nor electrical wiring. It is therefore ideal for permanent installations to define residential pedestrian areas, or for mixed installations which also feature other automatic or semi-automatic bollards.

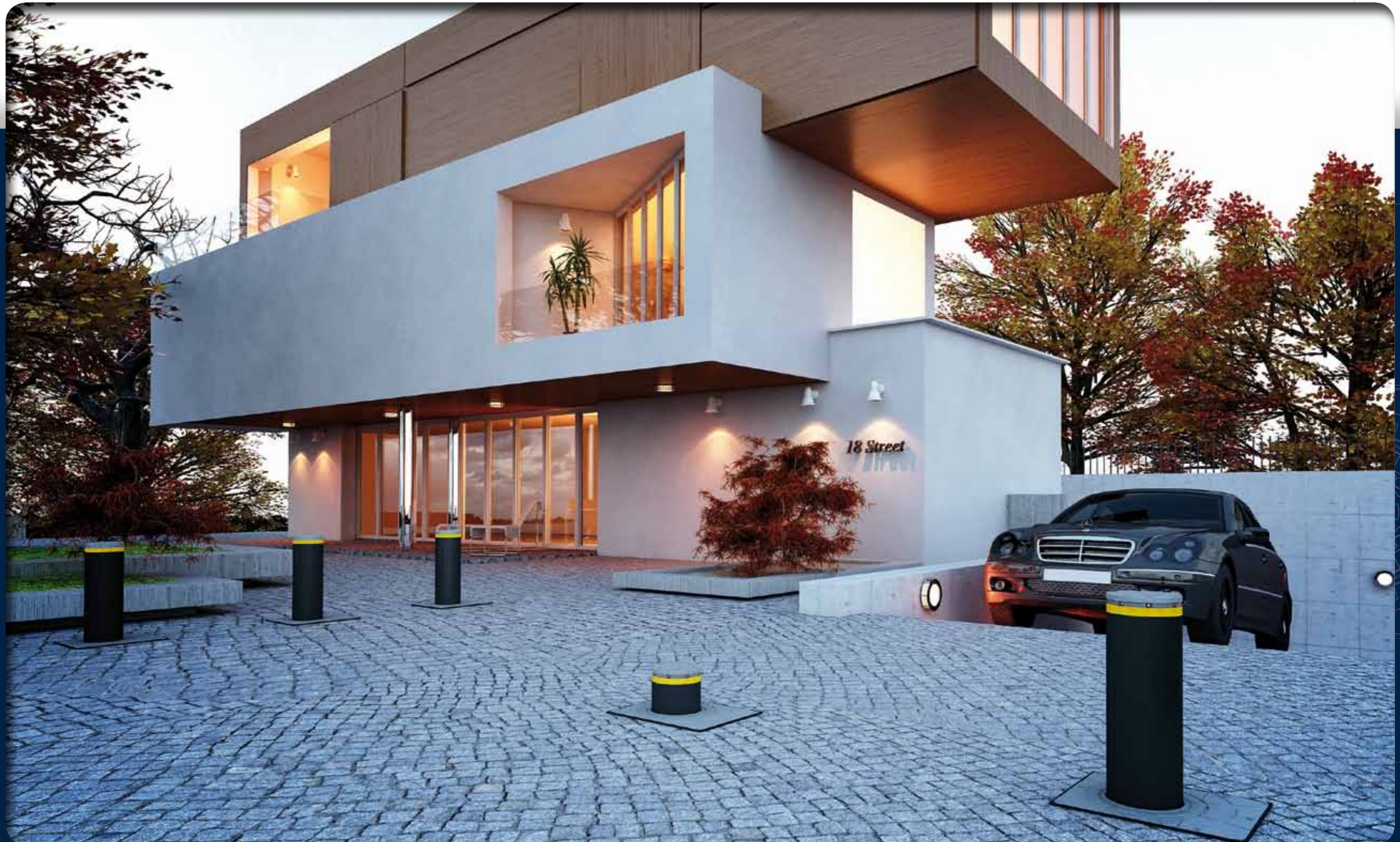

J200



# J200HA AUTOMATIC retractable traffic bollard

1. Easy to transport, store and install, thanks to the self-supporting structure - pit not required - and to the limited weight of the product
2. A streamlined product, configurable by selecting the desired installation accessories
3. Simplified maintenance (possible with just one person)
4. Fast and silent movement



## DIMENSIONS AND TECHNICAL SPECIFICATIONS

Drive	Hydraulic Actuator
Cylinder stroke	600 mm
Cylinder diameter	200 mm
Cylinder material standard version	Steel Fe 360 (6 mm thickness)
Standard cylinder surface treatment	Cataphoresis and polyester powder paint, dark grey metallised RAL 7021
Cylinder material special stainless steel version	Satin-finished AISI 316 (6 mm thick)
Cylinder top part (head)	Aluminium RAL 9006
Rise time	About 7 sec
Descent time	About 7 sec
Hydraulic pump power supply	230 Vac +6% - 10%; 50/60 Hz
Power consumption	230 W
Protection rating	IP 56
Recommended Use	Use in Residential areas
Standard refracting strip	Height 25 mm
Manual lowering operation	Possible with hydraulic circuit mechanical release
Total weight	90 kg
Operating temperature	-15 °C / +55 °C
Operating temperature with heater (opt.)	-25 °C / +55 °C
Dimensions	400x500x800 mm
Connection cable	Standard 16+1 conductors, minimum section 1.5 mm (not supplied)
Maximum length	50 m

## STANDARD VERSIONS IN PAINTED STEEL

Models	Height	Finish	Item code
J200 HA 600	600 mm	Painted steel	116500

### The product comes with:

- 5 mm thick steel cylinder with cataphoresis treatment and painted
- powder coated dark grey metallised RAL 7021
- hydraulic lock in raised position (in the event of a power cut) with special release key
- support structure to be cemented with cataphoresis treatment (pits not required)

## STANDARD VERSIONS IN AISI 316 STAINLESS STEEL

Models	Height	Finish	Item code
J200 HA 600	600 mm	Satin-finished AISI 316 stainless steel	116505





### The product comes with:

- 5 mm thick stainless steel cylinder with satin-finish treatment
- hydraulic lock in raised position (in the event of a power cut) with special release key
- support structure to be cemented with cataphoresis treatment (pits not required)

## ELECTRONIC EQUIPMENT

Item	Item code	
Bollard electronic board JE275 able to manage up to four bollards J200 HA	116300	

## OPTIONAL ACCESSORIES

Item	Item code	
Pit heater J200HA	116501	
Release kit with pressure switch for J200HA	116502	
Acoustic buzzer J200HA	116503	
LED lights kit J200HA	116504	

500

J200HA



# J200F FIXED traffic bollard

1. Power supply and wiring not required
2. Simple installation and limited digging operations
3. Observance of aesthetic consistency in mixed installations with other retractable bollards
4. Easy to transport, store and install, thanks to the limited weight of the product

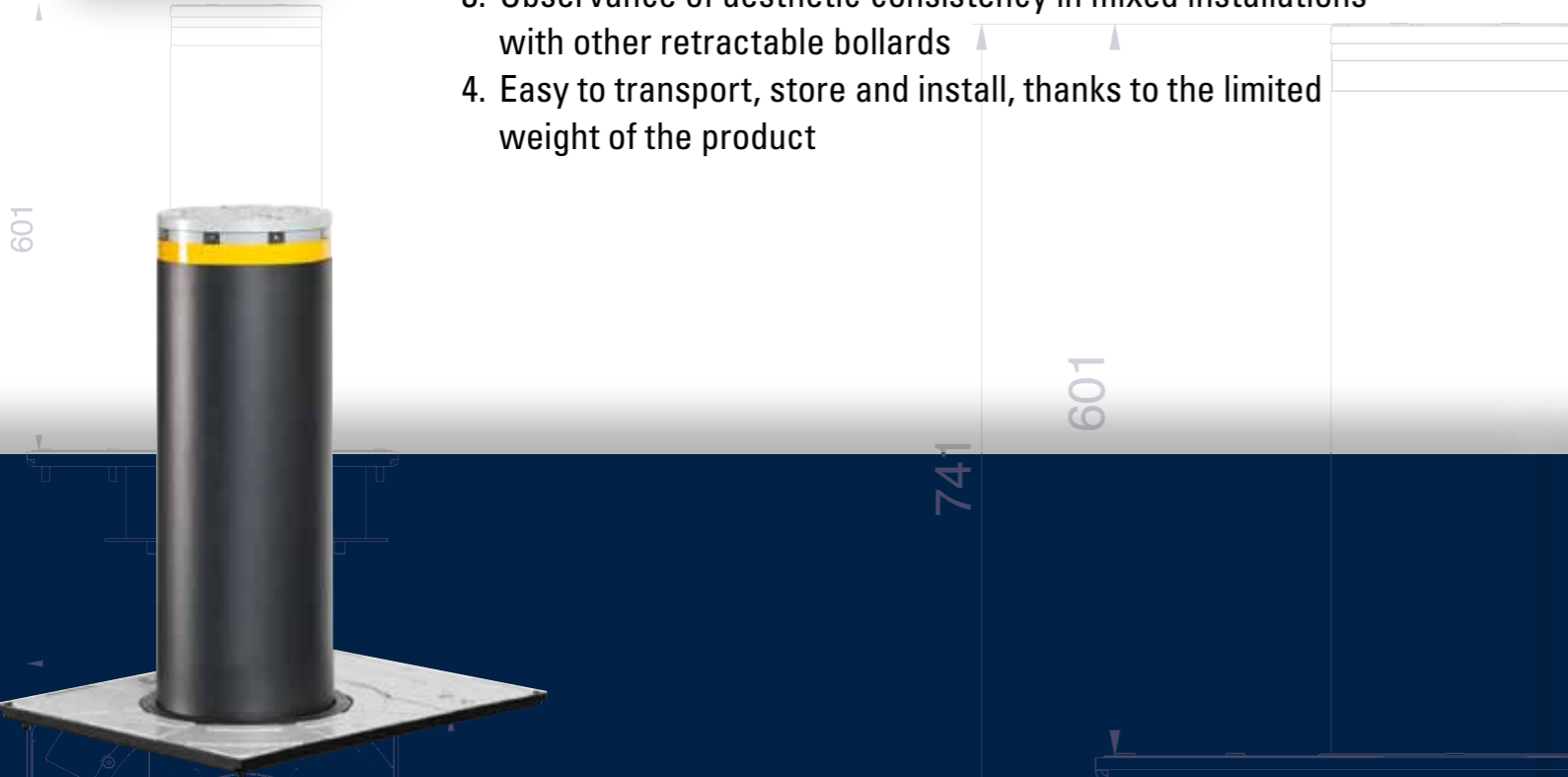

## STANDARD VERSIONS IN PAINTED STEEL

Models	Height	Finish	Item code
J200 F 600	600 mm	Painted steel	116506

### The product comes with:

- 5 mm thick steel cylinder with cathoresis treatment and painted
- powder coated dark grey metallised RAL 7021
- support structure to be cemented with cathoresis treatment (pits not required)

## STANDARD VERSIONS IN AISI 316 STAINLESS STEEL

Models	Height	Finish	Item code
J200 F 600	600 mm	Satin-finished AISI 316 stainless steel	1165067

### The product comes with:

- 5 mm thick stainless steel cylinder with satin-finished treatment
- support structure to be cemented with cathoresis treatment (pits not required)

## DIMENSIONS AND TECHNICAL SPECIFICATIONS

Cylinder height	600 mm
Cylinder diameter	200 mm
Cylinder material standard version	Steel Fe 360 (6 mm thickness)
Standard cylinder surface treatment	Cathoresis and polyester powder paint, dark grey metallised RAL 7021
Cylinder material special stainless steel version	Satin-finished AISI 316 (6 mm thick)
Cylinder top part (head)	Aluminium RAL 9006
Standard refracting strip	Height 25 mm

## OPTIONAL ACCESSORIES

Item	Item code
LED lights kit J200HA	116504



J200F



400

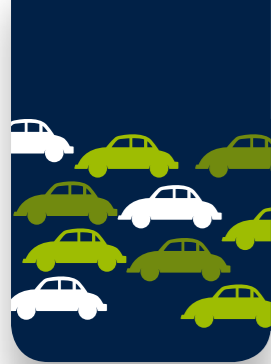

## Bollards for commercial, industrial and urban restricted access areas J275

Bollards J275 for the regulation of vehicle traffic within commercial areas, industrial areas and to manage urban restricted access areas

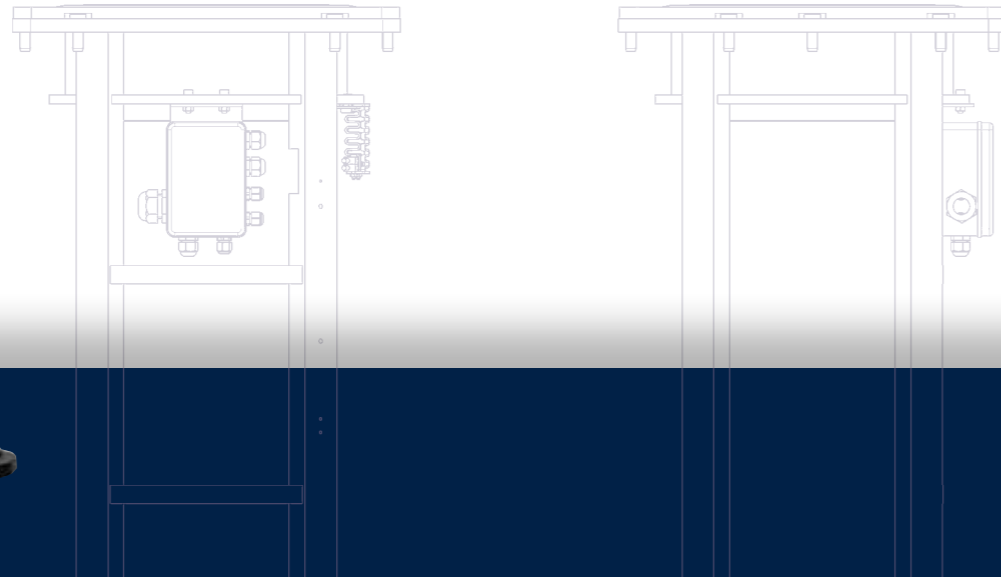

J275

### 1. J275HA AUTOMATIC RETRACTABLE TRAFFIC BOLLARD

The Automatic retractable traffic bollard J275HA is recommended for all areas when many daily transits are expected, i.e. commercial, industrial and urban restricted access areas.

### 2. J275SA SEMI-AUTOMATIC RETRACTABLE TRAFFIC BOLLARD

The Semi-Automatic retractable traffic bollard J275SA is particularly suitable for town centres and areas difficult to wire.

In fact, thanks to a gas actuator, raising and lowering is fully mechanical and does not require any electrical connection.

### 3. J275F FIXED TRAFFIC BOLLARD

The Fixed traffic bollard FAAC J275 does not require invasive installation work, nor electrical wiring. It is therefore ideal for permanent installations to define pedestrian areas, or for mixed installations which also feature other retractable bollards.

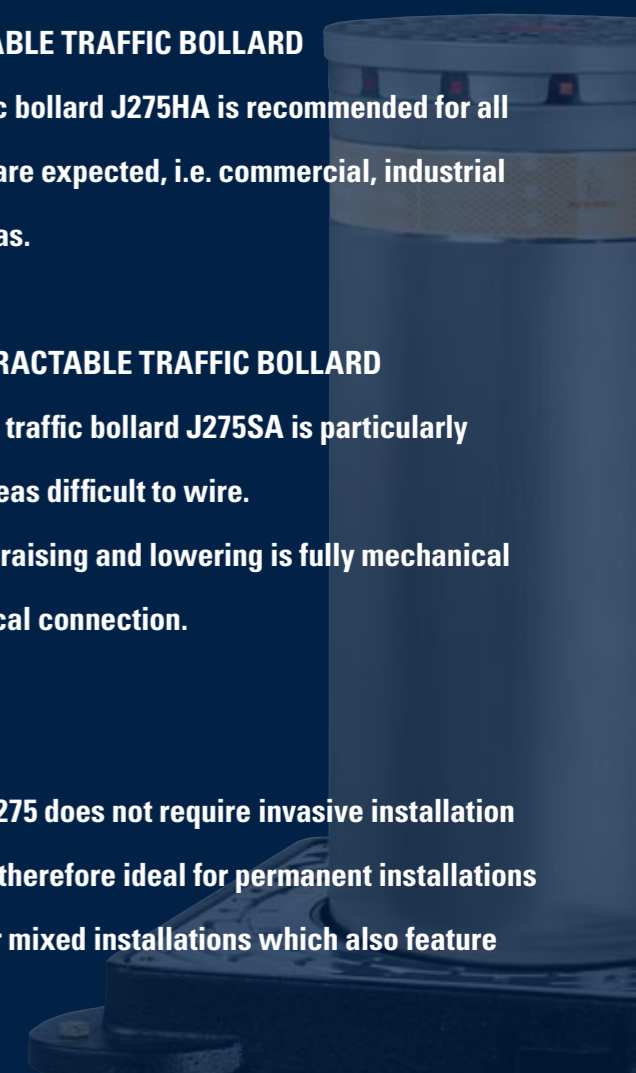



# J275HA AUTOMATIC retractable traffic bollard

1. Guaranteed for high frequency use
2. "Full optional" product; supplied equipped with the main accessories
3. Extreme care in the selection of materials
4. Simplified maintenance (possible with just one person)
5. Perfect interchangeability with first generation bollards
6. Fast and silent movement



## STANDARD VERSIONS IN PAINTED STEEL

Models	Height	Finish	Item code
J275 HA 600	600 mm	painted steel	116000
J275 HA 800	800 mm		116001

### The product comes with:

- 7 mm thick steel cylinder with cataphoresis treatment and painted
- powder paint, dark grey metallised RAL 7021
- flashing light ring with central LED
- acoustic movement buzzer
- emergency lowering in the event of a power cut (can be excluded)

## STANDARD VERSIONS IN AISI 316 STAINLESS STEEL

Models	Height	Finish	Item code
J275 HA 600	600 mm	satin-finished AISI 316 stainless steel	116030
J275 HA 800	800 mm		116031

### The product comes with:

- 6 mm thick stainless steel cylinder with satin-finished treatment
- flashing light ring with central LED
- acoustic movement buzzer
- emergency lowering in the event of a power cut (can be excluded)



## DIMENSIONS AND TECHNICAL SPECIFICATIONS

	Hydraulic Actuator	
	600 mm	800 mm
Drive	Hydraulic Actuator	
Cylinder stroke	600 mm	800 mm
Cylinder diameter	275 mm	
Cylinder material standard version	Steel Fe 360 (7 mm thickness)	
Standard cylinder surface treatment	Cataphoresis and polyester powder paint, dark grey metallised RAL 7021.	
Cylinder material special stainless steel version	Satin-finished AISI 316 (6 mm thickness)	
Cylinder top part (head)	Aluminium RAL 9006	
Rise time	About 5 sec	About 7 sec.
Descent time (standard)	About 2.8 sec	About 3.5 sec
Descent time (rapid) (*)	ABOUT 1 SEC	ABOUT 1.2 SEC
Hydraulic pump power supply	230 Vac +6% - 10%; 50/60 Hz	
Power consumption	220 W	
Protection rating	IP 56	
Recommended use	Intensive use (Traffic)	
Standard refracting strip	Height 55 mm	
Manual lowering operation	Possible with hydraulic circuit mechanical release	
Impact resistance	38 KJoules/painted steel - 67 KJoules/stainless steel	
Break-in resistance	128 KJoules/painted steel - 207 KJoules/stainless steel	
Total weight	112kg (diss.) + 55kg (pit)	130kg (diss.) + 65kg (pit)
Operating temperature	-15 °C / +55 °C	
Operating temperature with heater (optional)	-25 °C / +55 °C	
Pit to be walled in with modular cylinder profile	560x560x950 mm	560x560x1,220 mm
Connection cable	Standard 16+1 conductors, minimum section 1,5 mm (not supplied)	
Maximum length	50 m	

## ELECTRONIC EQUIPMENT



Item	Item code	
Bollard electronic board JE275 able to manage up to four bollards J275 HA	116300	

## INSTALLATION ACCESSORIES

Item	Item code	
Pit JP 275/600 for bollard H600 complete with counter frame	116100	
Pit extension JP 275/800* for bollard H800*	1161001	

(\*) For the 800 mm version the following two elements must be ordered: 116100 + 116101.

## OPTIONAL ACCESSORIES

Item	Item code	
Pit heater JH275 (to extend operation up to -25°C)	116200	
Pit cover JC275	116201	

J275HA



# J275SA SEMI-AUTOMATIC retractable traffic bollard

1. Power supply and wiring not required
2. Simple and safe movement, thanks to the specific release key
3. "Full optional" product; supplied equipped with the main accessories
4. Low position lock guaranteed against accidental release
5. Extremely simple maintenance



## STANDARD VERSIONS IN PAINTED STEEL

Models	Height	Finish	Item code
J275 SA 600	600 mm	powder paint, dark grey metallised RAL 7021	116050

### The product comes with:

- 7 mm thick steel cylinder with cataphoresis treatment and painted
- powder paint, dark grey metallised RAL 7021
- flashing light ring with central LED
- mechanical lock in raised position with special release key (2 release keys supplied as standard)

## STANDARD VERSIONS IN AISI 316 STAINLESS STEEL

Models	Height	Finish	Item code
J275 SA 600	600 mm	satin-finished AISI 316 stainless steel	116060

### The product comes with:

- 6 mm thick stainless steel cylinder with satin-finished treatment
- flashing light ring with central LED\*
- mechanical lock in raised position with special release key (2 release keys supplied as standard)

(\* ) The power supply unit (24 Vdc) and the cable (2x1.5 mm) for the illuminated ring are not supplied.

## DIMENSIONS AND TECHNICAL SPECIFICATIONS

Drive	Single-acting gas actuator
Cylinder stroke	600 mm
Cylinder diameter	275 mm
Cylinder material standard version	Steel Fe 360 (7 mm thickness)
Standard cylinder surface treatment	Cataphoresis and polyester powder paint, dark grey metallised RAL 7021
Cylinder material special stainless steel version	Satin-finished AISI 316 (6 mm thickness)
Cylinder top part (head)	Aluminium RAL 9006
Rise	Key release for automatic rise, with gas actuator
Descent	Key release for lowering, with pressure on the top of the cylinder
Standard refracting strip	Height 55 mm
Impact resistance	38 KJoules/painted steel - 67 KJoules/stainless steel
Break-in resistance	128 KJoules/painted steel - 207 KJoules/stainless steel
Total weight	70kg (bollard) + 55kg (pit)
Pit to be walled in with modular cylinder profile	560x560x950 mm

## INSTALLATION ACCESSORIES

Item	Item code	
Pit JP 275/600 for bollard H600 complete with counter frame	116100	

## OPTIONAL ACCESSORIES

Item	Item code	
Release keys kit (5 keys)	390084	
Pit cover JC275	116201	

J275SA





# J275F FIXED traffic bollard

1. Power supply and wiring not required
2. Simple installation and limited digging operations
3. Observance of aesthetic consistency in mixed installations with other retractable bollards
4. Possibility to remove the bollard to temporarily open the pedestrian area to traffic



## DIMENSIONS AND TECHNICAL SPECIFICATIONS

Cylinder height	600 mm	800 mm
Cylinder diameter	275 mm	
Cylinder material standard version	Steel Fe 360 (4 mm thickness)	
Standard cylinder surface treatment	Cataphoresis and polyester powder paint, dark grey metallised RAL 7021	
Cylinder material special stainless steel version	Satin-finished AISI 316 (3 mm thick)	
Cylinder top part (head)	Aluminium RAL 9006	
Standard refracting strip	Height 55 mm	
Break-in resistance	35 KJoules/painted steel -59 KJoules/stainless steel	
Total weight	34 kg (bollard)	38 kg (bollard)
Frame to be walled in	450 x 450 x 30 mm	

## STANDARD VERSIONS IN PAINTED STEEL

Models	Height	Finish	Item code
J275 F 600	600 mm	painted steel	116020
J275 F 800	800 mm		116021

### The product comes with:

- a 4 mm steel cylinder cataphoresis treated and painted
- powder coated dark grey metallised RAL 7021
- flashing light ring with central LED\*

## STANDARD VERSIONS IN AISI 316 STAINLESS STEEL

Models	Height	Finish	Item code
J275 F 600	600 mm	satin-finished AISI 316 stainless steel	116040
J275 F 800	800 mm		116041

### The product comes with:

- 3 mm thick stainless steel cylinder with satin-finished treatment
- flashing light ring with central LED\*

(\* ) The power supply unit (24 Vdc) and the cable (2x1.5 mm) for the illuminated ring are not supplied.

## INSTALLATION ACCESSORIES

Item	Item code
Fixed bollard fixing frame JPF275	116120



## OPTIONAL ACCESSORIES

Item	Item code
Pit cover JC275	116201



J275F



## J355HA-M30-P1 bollard certified for use in perimeter security areas

The AUTOMATIC bollard FAAC J355HA-M30-P1 is designed and tested for the protection of sensitive areas such as airports, embassies, consulates, banks, ports, etc.

The bollard FAAC J355HA-M30-P1 has been tested according to American Standard "ASTM F 2656-07 - Standard Test Method for Vehicle Crash Testing of Perimeter Barriers", obtaining certification for the highest class of penetration possible. Classification M30-P1 indicates in fact that the bollard FAAC J355 is able to stop a 6,800 kg lorry travelling at 50Km/h (=30M/h) with just 1 metre of total penetration (P1).



J355HA



# J355HA-M30-P1 bollard certified for use in perimeter security areas

1. CERTIFIED according to Standard ASTM F 2656-07 M30
2. "Full optional" product; supplied equipped with the main accessories
3. Lock in raised position guaranteed even in the event of a power cut
4. Extreme care in the selection of materials
5. Also available in the EFO (Emergency Fast Operation) version for very fast rise



## STANDARD VERSIONS IN PAINTED STEEL

Models	Height	Finish	Item code
J355 HA M30-P1	1,000 mm	painted steel	116002
J355 HA M30-P1 EFO			116003

### The product comes with:

- 16 mm thick steel cylinder with cataphoresis treatment and painted
- powder coated dark grey metallised RAL 7021
- flashing light ring with central LED
- hydraulic lock in raised position (in the event of a power cut)
- watertight galvanised steel pit with connection for recovery of fluids
- emergency circuit for fast rise (EFO version only)

## STANDARD VERSIONS IN AISI 316 STAINLESS STEEL

Models	Height	Finish	Item code
J355 HA M30-P1	1,000 mm	satin-finished AISI 316 stainless steel	116032
J355 HA M30-P1 EFO			116033

### The product comes with:

- 16 mm thick steel cylinder with cataphoresis treatment and satin-finished stainless steel «sleeve»
- flashing light ring with central LED
- hydraulic lock in raised position (in the event of a power cut)
- watertight galvanised steel pit with connection for recovery of fluids
- emergency circuit for fast rise (EFO version only)

## DIMENSIONS AND TECHNICAL SPECIFICATIONS

Drive	Hydraulic Actuator
Cylinder stroke	1,000 mm
Cylinder diameter	355 mm
Cylinder material	Steel S355JR EN10210 (16 mm thickness)
Cylinder surface treatment	Cataphoresis and polyester powder paint, dark grey metallised RAL 7021
Sleeve material (stainless steel special vers.)	Satin-finished AISI 316
Cylinder top part (head)	Aluminium RAL 9006
Rise time	About 6 sec/standard version - About 1.5 sec/EFO version
Descent time (standard)	About 2 sec
Hydraulic pump power supply	230 Vac +6% - 10%; 50/60 Hz
Power consumption	1,200 W
Maximum expressed force	5,000 N
Junction box protection rating	IP 66
Recommended Use	Use in security areas
Standard refracting strip	Height 55 mm
Impact resistance	150 Kjoules
Break-in resistance	656 KJoules (in compliance with Standards ASTM F2656-07 - M30)
Load class	C25 (25t)
Total weight	490 kg (bollard) + 250 kg (pit)
Operating temperature	-15 °C / +55 °C
Operating temperature with heater (optional)	-40 °C / +55 °C
Pit to be walled in	570x690x1665 mm
Connection cable	Standard 16+1 conductors, minimum section 1,5 mm (not supplied)
Maximum length	50 m

## ELECTRONIC EQUIPMENT

Item	Item code	
Bollard electronic board JE275 able to manage up to max 1 bollard J355 M30-P1	116300	

## INSTALLATION ACCESSORIES

Item	Item code	
Pit heater J355	116202	
Manual release key	116102	

J355HA



### J200 SERIES

DIAMETER	200 mm
HEIGHT	600 mm
FINISH	PAINTED STEEL, SATIN-FINISHED STAINLESS STEEL
VERSIONS	AUTOMATIC (HA); FIXED (F)



### J275 SERIES

DIAMETER	275 mm
HEIGHT	600 mm - 800 mm
FINISH	PAINTED STEEL, SATIN-FINISHED STAINLESS STEEL
VERSIONS	AUTOMATIC (HA); SEMI-AUTOMATIC (SA); FIXED (F)



### J355 SERIES

DIAMETER	355 mm
HEIGHT	1,000 mm
FINISH	PAINTED STEEL, SATIN-FINISHED STAINLESS STEEL
VERSIONS	AUTOMATIC (HA); AUTOMATIC + EMERGENCY FAST OPERATION (HA EFO)



## HEADQUARTERS

### ITALY

FAAC SpA  
Via Calari 10 - 40069 Zola Predosa (BO)  
Tel. +39 051 61724 - Fax +39 051 758518  
it.info@faacgroup.com - www.faacgroup.com

## SUBSIDIARIES

### AUSTRALIA

FAAC AUSTRALIA PTY LTD  
Homebush – Sydney, Australia  
tel. +61 2 87565644  
fax +61 2 87565677  
www.faac.com.au

### AUSTRIA

FAAC GMBH  
Salzburg, Austria  
tel. +43 662 8533950  
fax +43 662 85339525  
www.faac.at

### FAAC TUBULAR MOTORS

tel. +49 30 56796645  
fax +49 30 22409006  
faactm.info@faacgroup.com  
www.faac.at

### BENELUX

FAAC BENELUX NV/SA  
Brugge, Belgium  
tel. +32 50 320202  
fax +32 50 320242  
www.faacbenelux.com

### FAAC TUBULAR MOTORS

Schaapweg 30  
NL-6063 BA Vlodrop, Netherlands  
tel. +31 475 406014  
fax +31 475 406018  
faactm.info@faacgroup.com  
www.faacbenelux.com

### CHINA

FAAC SHANGHAI  
Shanghai, China  
tel. +86 21 68182970  
fax +86 21 68182968  
www.faacgroup.cn

### FRANCE

FAAC FRANCE  
Saint Priest - Lyon, France  
tel. +33 4 72218700  
fax +33 4 72218701  
www.faac.fr

### FAAC FRANCE - AGENCE PARIS

Massy - Paris, France  
tel. +33 1 69191620  
fax +33 1 69191621  
www.faac.fr

### FAAC FRANCE - DEPARTEMENT VOLETS

Saint Denis de Pile - Bordeaux, France  
tel. +33 5 57551890  
fax +33 5 57742970  
www.faac.fr

### GERMANY

FAAC GMBH  
Freilassing, Germany  
tel. +49 8654 49810  
fax +49 8654 498125  
www.faac.de

### FAAC TUBULAR MOTORS

tel. +49 30 56796645  
fax +49 30 22409006  
faactm.info@faacgroup.com  
www.faac.de

### INDIA

FAAC INDIA PVT. LTD  
Noida – Delhi, India  
tel. +91 120 3934100/4199  
fax +91 120 4212132  
www.faacindia.com

### IRELAND

NATIONAL AUTOMATION LTD  
Co. Roscommon, Ireland  
tel. +353 71 9663893  
fax: +353 71 9663890  
www.nal.ie

### MIDDLE EAST

FAAC MIDDLE EAST FZE  
Dubai Silicon Oasis Operation Center - Dubai, UAE  
tel. + 971 4 3724190  
fax+ 971 4 3724191  
www.faac.ae

### NETHERLANDS

KEMKO BV  
Doetinchem, Netherlands  
tel. +31 314 378777  
fax +31 314 362224  
www.kemko.nl

### NORDIC REGIONS

FAAC NORDIC AB  
Perstorp, Sweden  
tel. +46 435 779500  
fax +46 435 779529  
www.faac.se

### POLAND

FAAC POLSKA SP.ZO.O  
Warszawa, Poland  
tel. +48 22 8141422  
fax +48 22 8142024  
www.faac.pl

### RUSSIA

FAAC RUSSIA  
Moscow, Russia  
tel. +7 (495) 646 24 29  
www.faac.ru

### SPAIN

CLEM, S.A.U.  
San Sebastián de los Reyes - Madrid, Spain  
tel. +34 91 3581110  
fax +34 91 7293309  
www.faac.es

### SWITZERLAND

FAAC AG  
Altdorf, Switzerland  
tel. +41 41 8713440  
fax + 41 41 8713484  
www.faac.ch

### TURKEY

FAAC OTOMATİK GEÇİŞ SİSTEMLERİ LTD. ŞTİ.  
SAN. VE TİC. LTD. ŞTİ.  
İstanbul, Turkey  
tel.+90 (0)212 - 3431311  
www.faac.com.tr

### UNITED KINGDOM

FAAC UK LTD.  
Basingstoke - Hampshire, UK  
tel. +44 1256 318100  
fax +44 1256 318101  
www.faac.co.uk

### U.S.A.

FAAC INTERNATIONAL INC  
Jacksonville, FL - U.S.A.  
tel. +1 904 4488952  
fax +1 904 4488958

FAAC INTERNATIONAL INC  
Fullerton, California - U.S.A.  
tel. +1 714 446 9800  
fax +1 714 446 9898  
www.faacusa.com

**FAAC**  
Simply automatic.

